

# Ogi M technical specification



.mdd

**.mdd has a leading position among manufacturers of office furniture with many awards that prove quality and continuously increase demand for it's products.**

The realities of today`s market require constant quality improvement at all levels of modern organization. This applies in particular to customer service, marketing, quality of products and also to quality of processes within the company. Partnership relations among employees and with business partners form a base of economic growth and success of the company.

Constant investments in innovative machinery park, optimization of management systems and an expansion of production halls allow to minimize the lead times for the product of the highest quality.

**More than twenty years of experience in office furniture industry come with reference from a long list of companies and institutions to show their appreciation for an efficient and comprehensive service.**

**.mdd is highly aware of the environment.**

Being located in the forest region with lake by it's side, .mdd takes the nature seriously and invests constantly in a modern and energy-efficient solutions to preserve the local life. Company puts emphasis on waste segregation and recycling. .mdd has been awarded for the exceptional care and involvement in waste disposal. All materials used are environmentally friendly and enjoy a high 95 % rate of being recycled.



**General informations:**

**Warranty:**

.mdd products – 5 years.  
Electrical components and fabric – 2 years.

**Certificate – MFC:**



**Assembly:**

product delivered in separate elements

**Packing:**

cardboard, perforated plastic mesh wrap

**Compliant with standards:**

PN-EN 527-2:2017-02

**Boards density:**

12 mm – 690 – 750 kg/m<sup>3</sup>  
18 mm – 650 – 690 kg/m<sup>3</sup>  
28 mm – 610 – 630 kg/m<sup>3</sup>  
36 mm – 610 – 630 kg/m<sup>3</sup>

**Material composition \*:**

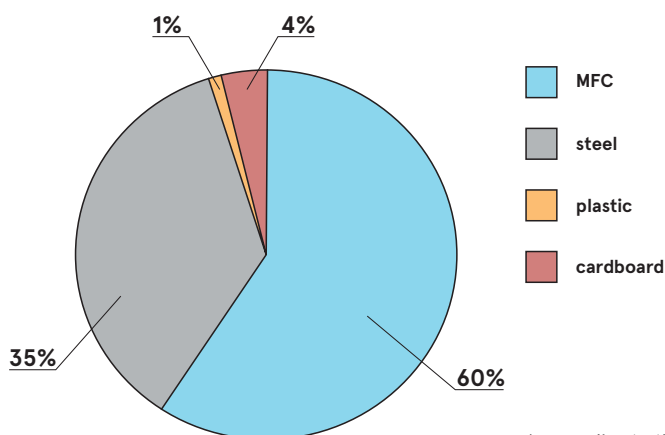

\* according to the EPD document

**Recyclability \*\***

Recyclable: 42% - Downcyclable: 58%

**Recycled content**

36%

**Co2 carbon footprint**

33,55 kg

\*\* average values for a representative of the group; values may vary for other products

## Ogi desk worktops

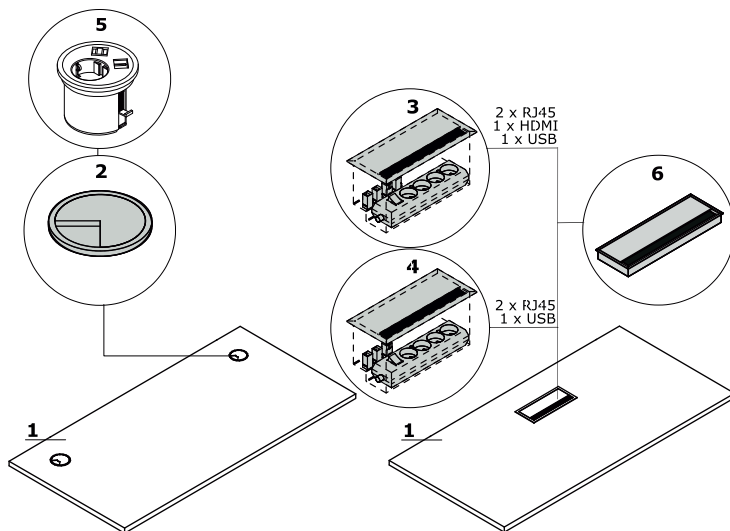

1. Worktop - MFC 28 mm, ABS edge
- OPTIONS WITH EXTRA CHARGE:**
2. Grommet - 2 pcs, Ø 80 mm
3. Mediabox M04H - 2 x RJ45 (class E, cat. 6); + 1 x USB + 1 x HDMI + 4 x 230V
4. Mediabox M04 - 2 x RJ45 (class E, cat. 6); + 1 x USB + 4 x 230V
5. Mediabox M07 - 1 x 230V + 1 x USB charger + 1 x RJ45, colour: black, white, mounted instead of the existing grommet Ø80 mm (Pk80)
6. Top access M05
7. Cable way - the width of the opening is proportional to the width of the worktop
8. Mediabox M07 + cable grommets
9. Cable way + cable grommets - desks, bench desks

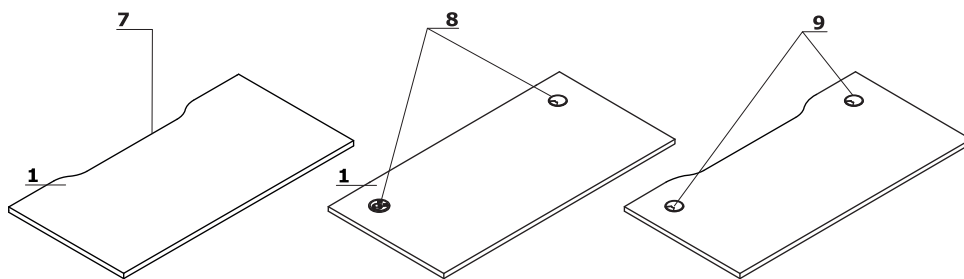

## Frame

Ogi M: metal, powder coated, profile 40 × 40 mm, spacer 10 mm between top and frame

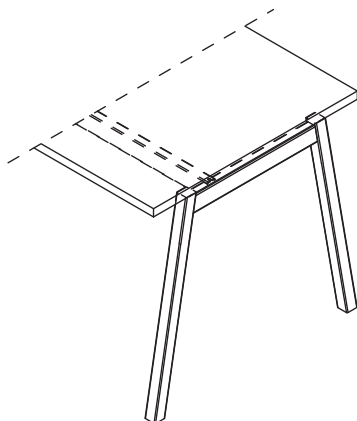

Attention - cable tray under the worktop is always in M009 - aluminium semi-matt colour.  
 Attention - leveling - 10 mm range.

Ogi M	Date of preparation 03.11.2022	The data contained in this document is valid in the day of its preparation. Change of the product, as long as it does not affect the basic features of it, does not require consistent updates of the document.	page 3/13 technical description
-------	-----------------------------------	---	------------------------------------

Desk with managerial storage

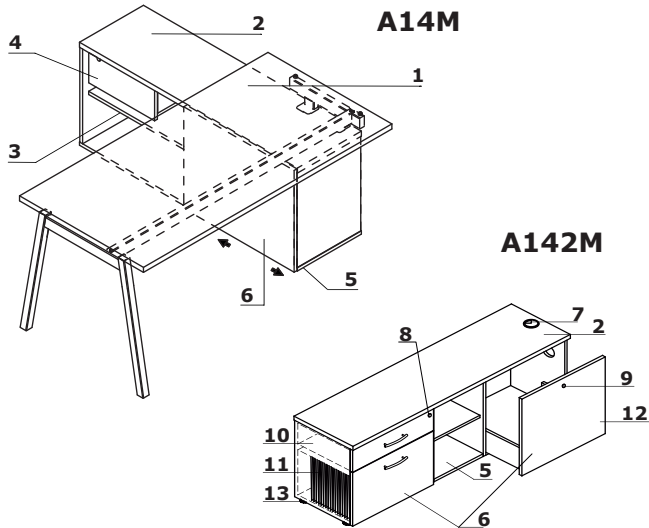

A14M:

- 1. **Worktop** - MFC 28 mm, ABS edge
- 2. **Top** - MFC 28 mm, ABS edge
- 3. **Shelf** - MFC 18 mm, protection against accidental falling-out, ABS edge
- 4. **Drawer** - MFC 18 mm, ABS edge, patent lock - possible to change location

- 5. **Base** - MFC 18 mm, ABS edge
- 6. **Front** - MFC 18 mm, ABS edge

A12M - OPTION WITH EXTRA CHARGE:

- 7. **Top** - MFC 28 mm, ABS edge
- 8. **Cable grommets** - Ø80 mm
- 9. **Base** - MFC 18 mm, ABS edge
- 10. **Front** - MFC 18 mm, ABS edge
- 11. **Central lock** - foldable key
- 12. **Patent lock**
- 13. **Metal drawer** - roll runners, max load 25 kg, 80% extraction, anti-tilt mechanism
- 14. **Suspension files drawer** - with bottom, ball runners, max load 45kg, 100% extraction, Push-to-Open
- 15. **Drawer with bottom** - ball runners, max. load 40 kg, 100 % extraction, push-to-open, enough space for computer
- 16. **Leveling feet** - range 5 mm

Configuration examples - desk with managerial storage - A14M (mm)

www.mdd.eu

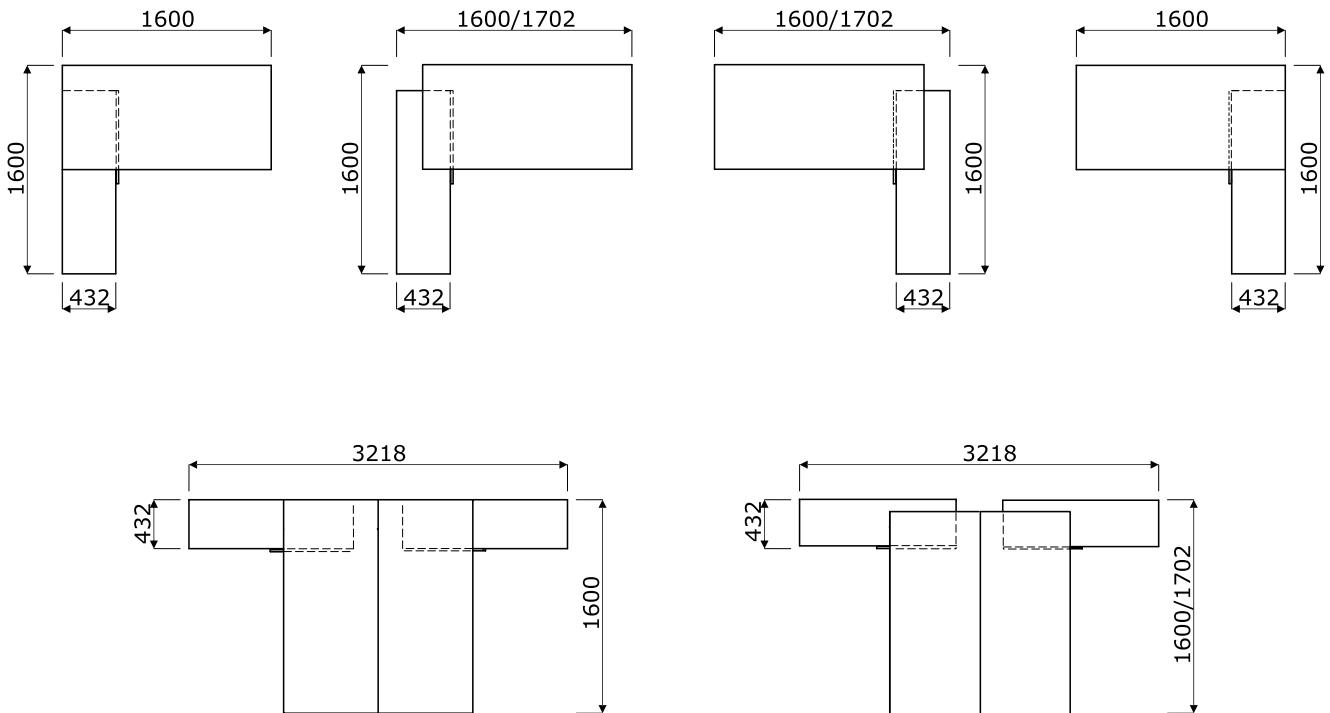

Configuration examples - desk with managerial storage - A12M (mm)

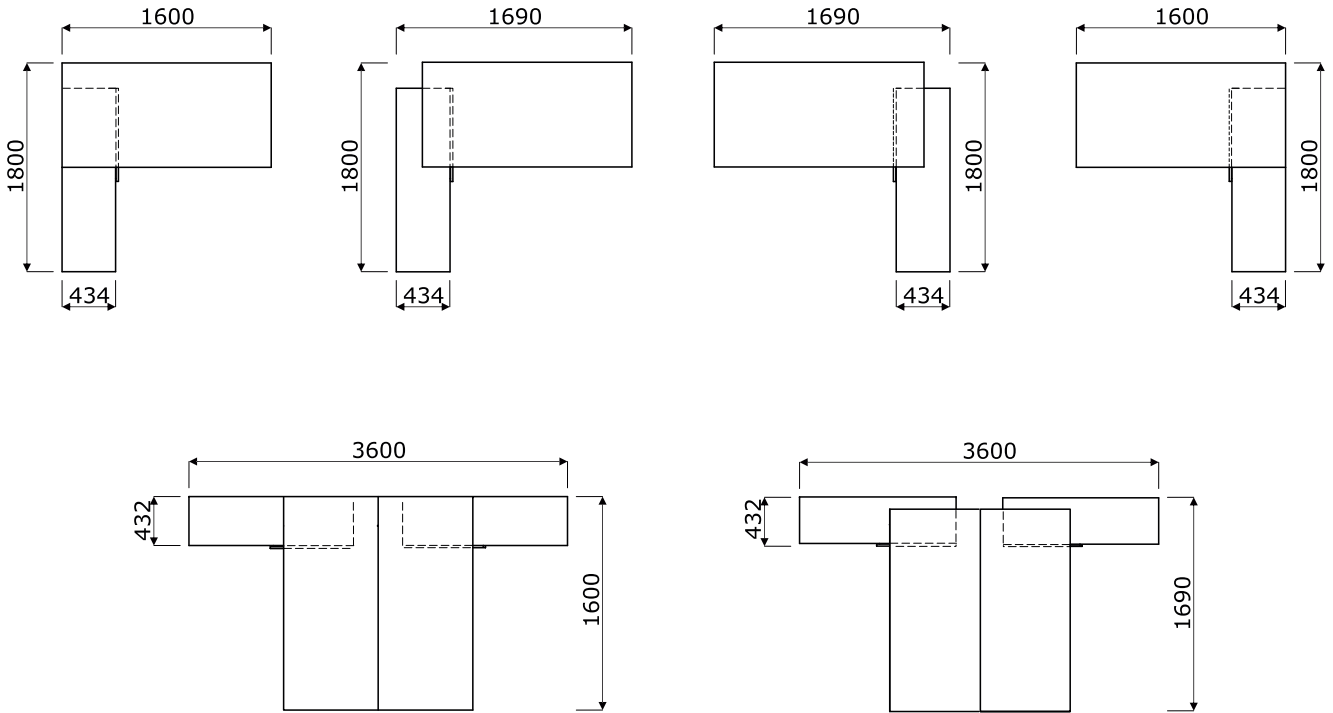

Configuration examples with BOX40, BOX50, BOX60

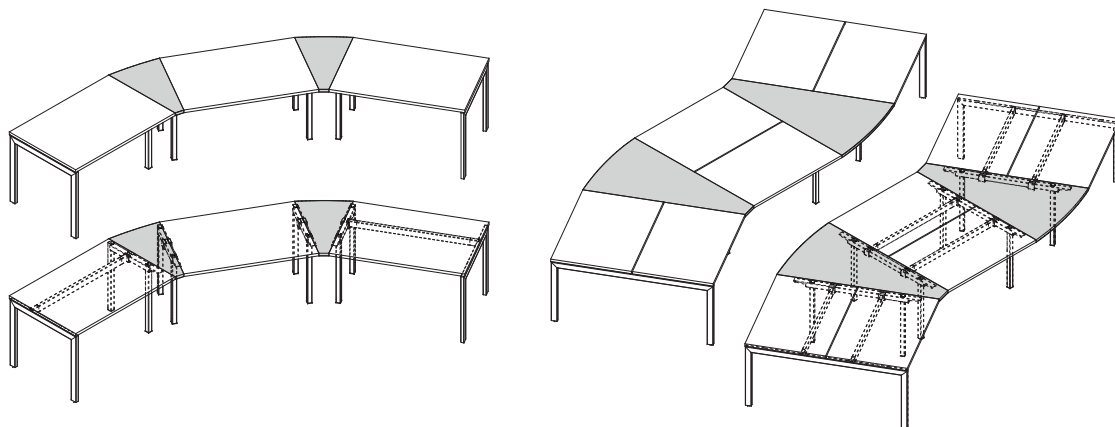

ATTENTION – only for Ogi Q, Ogi U, Ogi Y, Ogi M

Accessories

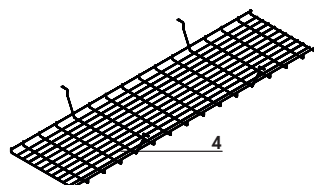
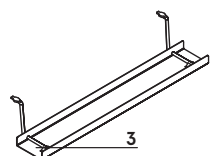
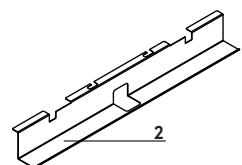
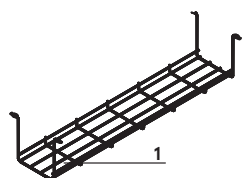

- 1. Horizontal cable tray S69 – powder coated
- 2. Single desk horizontal cable tray (SG12, SG16) – powder coated metal
- 3. Horizontal cable tray E64 – powder coated
- 4. Cable tray for bench desks (SG220, SG260) – steel wire Ø4 mm, powder coated

www.mdd.eu

Sliding top

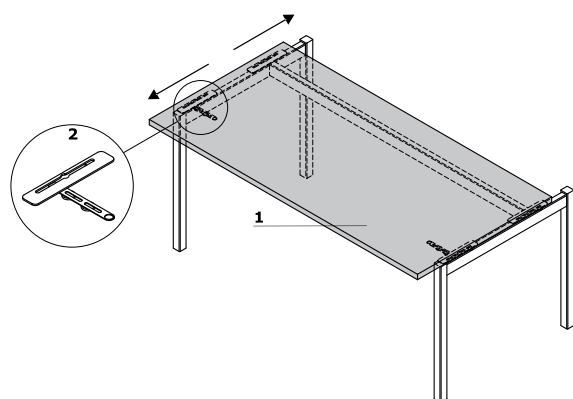

- 1. Sliding top – shifting range 141 mm
- 2. Tabletop sliding lock

Note – M04, M04H, and M07 mediaboxes cannot be installed.

Ogi M	Date of preparation 03.11.2022	The data contained in this document is valid in the day of its preparation. Change of the product, as long as it does not affect the basic features of it, does not require consistent updates of the document.	page 6/13 technical description
-------	-----------------------------------	---	------------------------------------

Power strip - for series connection

- 1. **PWS1** - set for 1 workstation - power strip (3x SCHUCKO, 2x RJ45) x1 + power cord (universal outlet PL/FR/Schucko)
- 2. **PWS2** - set for 2 workstation - power strip (3x SCHUCKO, 2x RJ45) x2 + set of power cords (universal outlet PL/FR/Schucko)
- 3. **PWS3** - set for 3 workstation - power strip (3x SCHUCKO, 2x RJ45) x3 + set of power cords (universal outlet PL/FR/Schucko)

1

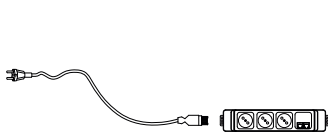

2

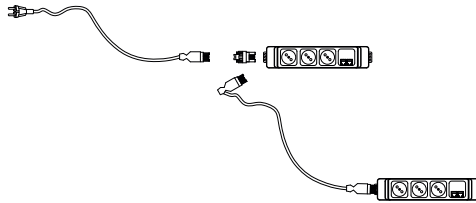

3

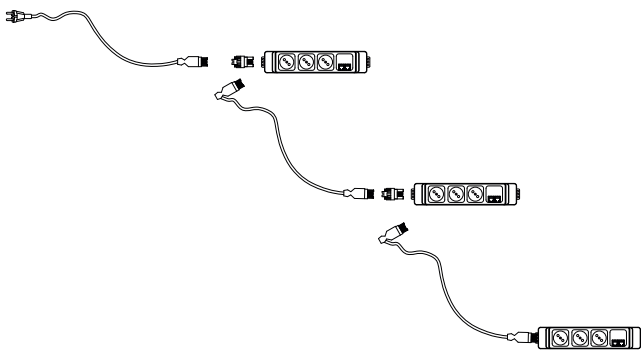

Elements for desks pairing

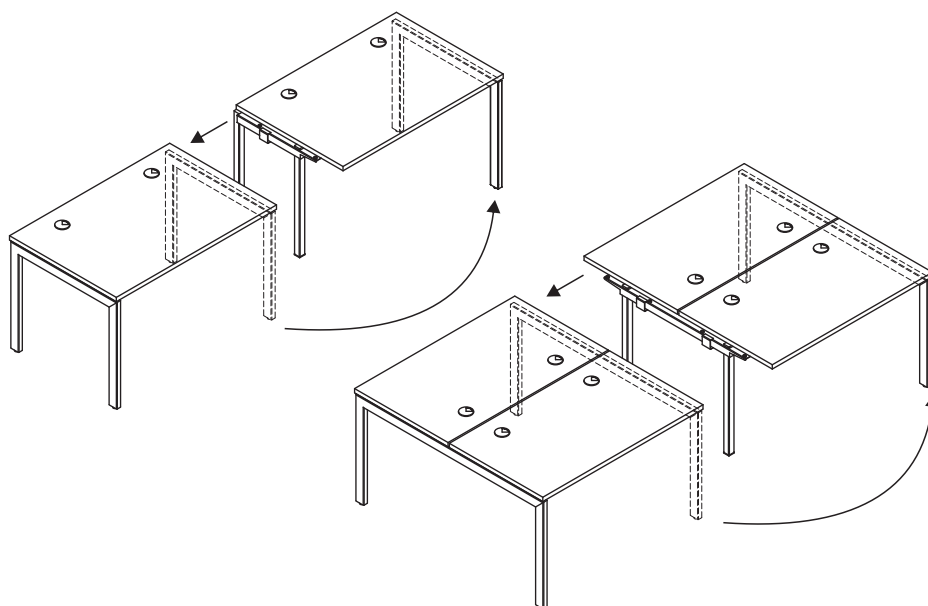

Desks \*



**BOM10**  
1000 / 600 / 740  
24.4 kg



**BOM12**  
1200 / 600 / 740  
26.3 kg



**BOM14**  
1400 / 600 / 740  
33.05 kg



**BOM16**  
1600 / 600 / 740  
32.5 kg



**BOM19**  
1000 / 700 / 740  
27.05 kg



**BOM22**  
1200 / 700 / 740  
32.7 kg



**BOM24**  
1400 / 700 / 740  
33.8 kg



**BOM26**  
1600 / 700 / 740  
40.5 kg



**BOM02**  
1200 / 800 / 740  
35 kg



**BOM03**  
1400 / 800 / 740  
37.75 kg



**BOM04**  
1600 / 800 / 740  
42.05 kg



**BOM05**  
1800 / 800 / 740  
46.55 kg



**BOM06**  
2000 / 800 / 740  
49.6 kg

\* dimensions expressed in millimeters: width x depth x height



Elements for arrangement building - straight desk \*

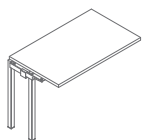

**BOX10**  
1000 / 600 / 740  
20.87 kg

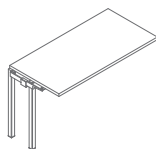

**BOX12**  
1200 / 600 / 740  
22.7 kg

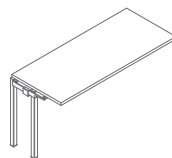

**BOX14**  
1400 / 600 / 740  
29.45 kg

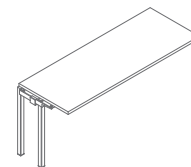

**BOX16**  
1600 / 600 / 740  
28.9 kg

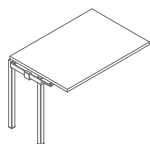

**BOX30**  
1000 / 700 / 740  
23.45 kg

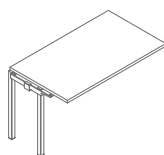

**BOX32**  
1200 / 700 / 740  
29.1 kg

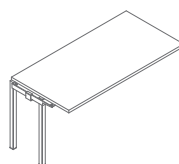

**BOX34**  
1400 / 700 / 740  
30.2 kg

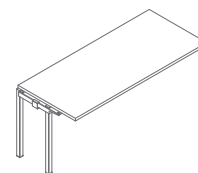

**BOX36**  
1600 / 700 / 740  
36.9 kg



**BOX40**  
500 / 800 / 740  
11 kg

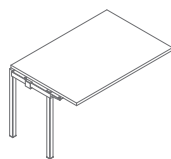

**BOX42**  
1200 / 800 / 740  
30.8 kg

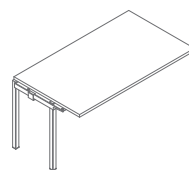

**BOX43**  
1400 / 800 / 740  
33.55 kg

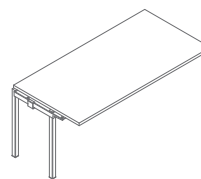

**BOX44**  
1600 / 800 / 740  
37.85 kg

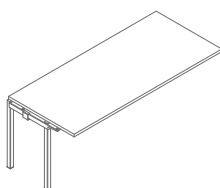

**BOX45**  
1800 / 800 / 740  
42.35 kg

\* dimensions expressed in millimeters: width x depth x height

**Bench desks \***

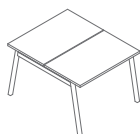

**BOM50**  
1000 / 1210 / 740  
42.8 kg



**BOM52**  
1200 / 1210 / 740  
46.6 kg

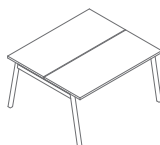

**BOM54**  
1400 / 1210 / 740  
60.1 kg



**BOM56**  
1600 / 1210 / 740  
59 kg

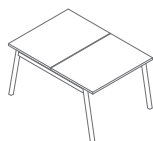

**BOM48**  
1000 / 1410 / 740  
49.1 kg

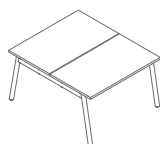

**BOM42**  
1200 / 1410 / 740  
60.4 kg

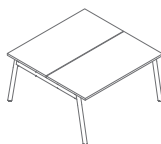

**BOM44**  
1400 / 1410 / 740  
62.6 kg



**BOM46**  
1600 / 1410 / 740  
76 kg

www.mdd.eu

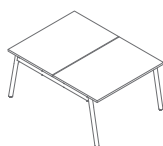

**BOM32**  
1200 / 1610 / 740  
64 kg

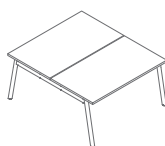

**BOM33**  
1400 / 1610 / 740  
69.5 kg

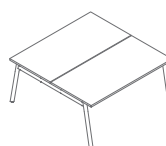

**BOM34**  
1600 / 1610 / 740  
78.1 kg

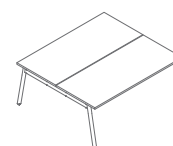

**BOM35**  
1800 / 1610 / 740  
87.1 kg

**Elements for arrangement building - bench \***

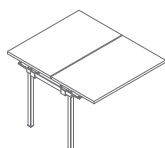

**BOX20**  
1000 / 1210 / 740  
36.8 kg

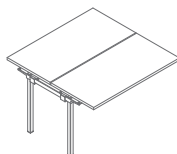

**BOX22**  
1200 / 1210 / 740  
40.6 kg

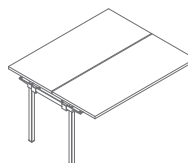

**BOX24**  
1400 / 1210 / 740  
54.1 kg

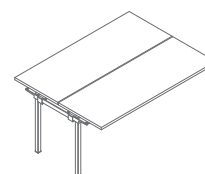

**BOX26**  
1600 / 1210 / 740  
53 kg

\* dimensions expressed in millimeters: width x depth x height

Elements for arrangement building - bench \*



**BOX50**  
1000 / 1410 / 740  
24.05 kg

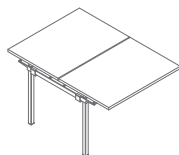

**BOX51**  
1000 / 1410 / 740  
43.7 kg

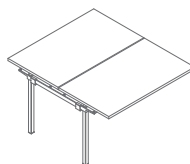

**BOX52**  
1200 / 1410 / 740  
55 kg

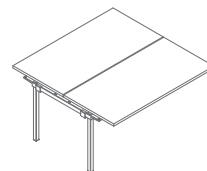

**BOX54**  
1400 / 1410 / 740  
57.2 kg

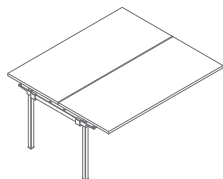

**BOX56**  
1600 / 1410 / 740  
70.6 kg



**BOX60**  
1000 / 1610 / 740  
28.75 kg

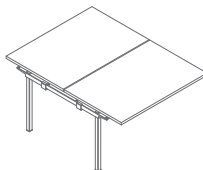

**BOX62**  
1200 / 1610 / 740  
58.35 kg

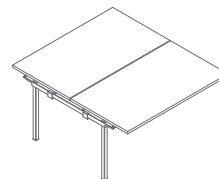

**BOX64**  
1400 / 1610 / 740  
63.85 kg

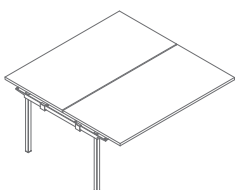

**BOX66**  
1600 / 1610 / 740  
72.45 kg

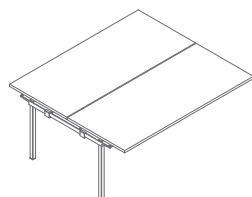

**BOX68**  
1800 / 1610 / 740  
81.45 kg

www.mdd.eu

Desks with managerial storage \*

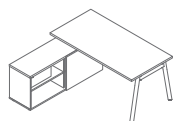

**BOM20**  
1702-1600 / 1600 / 740  
108.3 kg

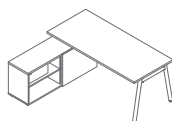

**BOM21**  
1902-1800 / 1600 / 740  
111.2 kg

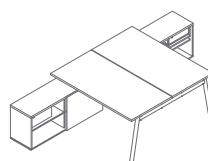

**BOM40**  
1702-1600 / 3210 / 740  
210.4 kg

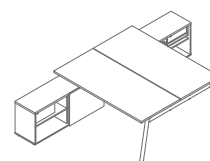

**BOM41**  
1902-1800 / 3210 / 740  
219.4 kg

\* dimensions expressed in millimeters: width x depth x height

Desk extensions \*



**POM01**  
600 / 800 / 740  
15.65 kg



**POM02**  
600 / 1000 / 740  
19.4 kg



**POM03**  
600 / 1200 / 740  
20 kg

Power strip



**PWS1**  
500 / 430 / 569  
1.1 kg



**PWS2**  
500 / 430 / 569  
1.6 kg

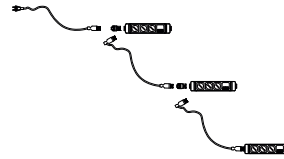

**PWS3**  
500 / 430 / 569  
2.1 kg

\* dimensions expressed in millimeters: width x depth x height

<b>Ogi M</b>	Date of preparation 03.11.2022	The data contained in this document is valid in the day of its preparation. Change of the product, as long as it does not affect the basic features of it, does not require consistent updates of the document.	page 12/13
			<b>products</b>

## Worktop, top, base, body, front



## Frame - metal



## Mediabox - metal



## Grommets



## Accessories

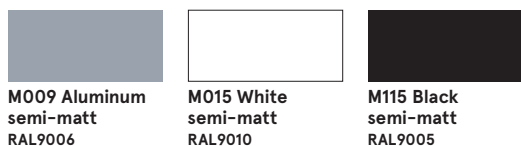

\* body - II group

\*\* additional charge option: one-time charge for the colour (200 €) + 10% of the product value

Ogi M	Date of preparation 03.11.2022	The data contained in this document is valid in the day of its preparation. Change of the product, as long as it does not affect the basic features of it, does not require consistent updates of the document.	page 13/13
			colours